

Data Projector

Operating Instructions

VPL-ES3
VPL-EX3

WARNING

To reduce the risk of fire or electric shock, do not expose this apparatus to rain or moisture.

To avoid electrical shock, do not open the cabinet. Refer servicing to qualified personnel only.

WARNING

THIS APPARATUS MUST BE EARTHED.

IMPORTANT

The nameplate is located on the bottom.

WARNING

This unit has no power switch. When installing the unit, incorporate a readily accessible disconnect device in the fixed wiring, or connect the power cord to socket-outlet which must be provided near the unit and easily accessible.

If a fault should occur during operation of the unit, operate the disconnect device to switch the power supply off, or disconnect the power cord.

CAUTION

Danger of explosion if battery is incorrectly replaced.

Replace only with the same or equivalent type recommended by the manufacturer.

Dispose of used batteries according to the manufacturer's instructions.

For the customers in the USA

This equipment has been tested and found to comply with the limits for a Class B digital device, pursuant to Part 15 of the FCC Rules. These limits are designed to provide reasonable protection against harmful interference in a residential installation. This equipment generates, uses, and can radiate radio frequency energy and, if not installed and used in accordance with the instructions, may cause harmful interference to radio communications. However, there is no guarantee that interference will not occur in a particular installation. If this equipment

does cause harmful interference to radio or television reception, which can be determined by turning the equipment off and on, the user is encouraged to try to correct the interference by one or more of the following measures:

- Reorient or relocate the receiving antenna.
- Increase the separation between the equipment and receiver.
- Connect the equipment into an outlet on a circuit different from that to which the receiver is connected.
- Consult the dealer or an experienced radio/TV technician for help.

You are cautioned that any changes or modifications not expressly approved in this manual could void your authority to operate this equipment.

All interface cables used to connect peripherals must be shielded in order to comply with the limits for a digital device pursuant to Subpart B of Part 15 of FCC Rules.

This device complies with Part 15 of the FCC Rules. Operation is subject to the following two conditions: (1) This device may not cause harmful interference, and (2) this device must accept any interference received, including interference that may cause undesired operation.

If you have any questions about this product, you may call:

Sony Customer Information Service Center
1-800-222-7669 or <http://www.sony.com/>

The number below is for FCC related matters only.

Declaration of Conformity

Trade Name: SONY

Model: VPL-ES3, VPL-EX3

Responsible Party: Sony Electronics Inc.

Address: 16530 Via Esprillo,
San Diego, CA 92127 U.S.A.

Telephone Number: 858-942-2230

WARNING: THIS WARNING IS APPLICABLE FOR USA ONLY.

If used in USA, use the UL LISTED power cord specified below.

DO NOT USE ANY OTHER POWER CORD.

Plug Cap	Parallel blade with ground pin (NEMA 5-15P Configuration)
Cord	Type SJT, three 16 or 18 AWG wires
Length	Minimum 1.5m (4 ft .11 in.), Less than 2.5 m (8 ft .3 in.)
Rating	Minimum 10A, 125V

Using this unit at a voltage other than 120V may require the use of a different line cord or attachment plug, or both.

To reduce the risk of fire or electric shock, refer servicing to qualified service personnel.

WARNING: THIS WARNING IS APPLICABLE FOR OTHER COUNTRIES.

1. Use the approved Power Cord (3-core mains lead) / Appliance Connector / Plug with earthing-contacts that conforms to the safety regulations of each country if applicable.
2. Use the Power Cord (3-core mains lead) / Appliance Connector / Plug conforming to the proper ratings (Voltage, Ampere).

If you have questions on the use of the above Power Cord /Appliance Connector /Plug, please consult a qualified service personnel.

Voor de klanten in Nederland

- Gooi de batterij niet weg maar lever deze in als klein chemisch afval (KCA).
- Dit apparaat bevat een vast ingebouwde batterij die niet vervangen hoeft te worden tijdens de levensduur van het apparaat.
- Raadpleeg uw leverancier indien de batterij toch vervangen moet worden. De batterij mag alleen vervangen worden door vakbekwaam servicepersoneel.
- Lever het apparaat aan het einde van de levensduur in voor recycling, de batterij zal dan op correcte wijze verwerkt worden.



Disposal of Old Electrical & Electronic Equipment (Applicable in the European Union and other European countries with separate collection systems)



This symbol on the product or on its packaging indicates that this product shall not be treated as household waste. Instead it shall be handed over to the applicable collection point for the recycling of electrical and electronic equipment. By ensuring this product is disposed of correctly, you will help prevent potential negative consequences for the environment and human health, which could otherwise be caused by inappropriate waste handling of this product. The recycling of materials will help to conserve natural resources. For more detailed information about recycling of this product, please contact your local city office, your household waste disposal service or the shop where you purchased the product.

For the customers in Taiwan only



廢電池請回收

Table of Contents

Precautions 5
Notes on Installation and Usage 6

The INSTALL SETTING Menu31
The INFORMATION Menu32

Overview

Features 8
Location and Function of Controls9
 Top/Right Side/Front 9
 Rear/Bottom 9
 Control Panel 10
 Connector Panel 11
 Remote Commander 11

Projecting the Picture

Installing the Projector 13
Connecting the Projector 14
 Connecting a Computer 14
 Connecting a VCR 15
Projecting 16
Turning Off the Power 18

Convenient Functions

Selecting the Menu Language 19
Security Lock 20
Effective Tools for Your
 Presentation 21

Adjustments and Settings Using a Menu

Using a MENU 23
The PICTURE SETTING Menu 25
The INPUT SETTING Menu 26
 About the Preset Memory No. ... 27
The SET SETTING Menu 28
The MENU SETTING Menu 30

Maintenance

Replacing the Lamp34
Cleaning the Air Filter36

Others

Troubleshooting37
 Messages List39
Specifications41
Installation Diagram46
 Floor Installation (Front
 Projection)46
 Ceiling Installation (Front
 Projection)48
Dimensions50
Index51

Precautions

Safety

- Check that the operating voltage of your unit is identical with the voltage of your local power supply.
- Should any liquid or solid object fall into the cabinet, unplug the unit and have it checked by qualified personnel before operating it further.
- Unplug the unit from the wall outlet if it is not to be used for several days.
- To disconnect the cord, pull it out by the plug. Never pull the cord itself.
- The wall outlet should be near the unit and easily accessible.
- The unit is not disconnected to the AC power source (mains) as long as it is connected to the wall outlet, even if the unit itself has been turned off.
- Do not look into the lens while the lamp is on.
- Do not place your hand or objects near the ventilation holes. The air coming out is hot.
- Be careful not to get your fingers caught in the adjuster.
- Do not spread a cloth or paper under the unit.

Illumination

- To obtain the best picture, the front of the screen should not be exposed to direct lighting or sunlight.
- Ceiling-mounted spot lighting is recommended. Use a cover over fluorescent lamps to avoid lowering the contrast ratio.
- Cover any windows that face the screen with opaque draperies.
- It is desirable to install the unit in a room where floor and walls are not of light-reflecting material. If the floor and walls are of reflecting material, it is recommended that the carpet and wall paper be changed to a dark color.

Preventing internal heat build-up

After you turn off the power with the I/⏻ key, do not disconnect the unit from the wall outlet while the cooling fan is still running.

Caution

The unit is equipped with ventilation holes (intake) and ventilation holes (exhaust). Do not block or place anything near these holes, or internal heat build-up may occur, causing picture degradation or damage to the projector.

Cleaning

- To keep the cabinet looking new, periodically clean it with a soft cloth. Stubborn stains may be removed with a cloth lightly dampened with a mild detergent solution. Never use strong solvents, such as thinner, benzene, or abrasive cleansers, since these will damage the cabinet.
- Avoid touching the lens. To remove dust on the lens, use a soft dry cloth. Do not use a damp cloth, detergent solution, or thinner.
- Clean the filter at regular intervals.

LCD data projector

- This LCD data projector is manufactured using high-precision technology. You may, however, see tiny black points and/or bright points (red, blue, or green) that appear continuously on the LCD data projector. This is a normal result of the manufacturing process and does not indicate a malfunction.

Notes on Installation and Usage

Unsuitable Installation

Do not install the projector in the following situations. **Installation in these situations or locations may cause a malfunction or damage** to the unit.

Poorly ventilated locations

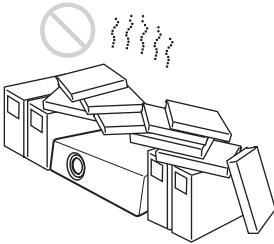

- Allow adequate air circulation to prevent internal heat build-up. Do not place the unit on surfaces (rugs, blankets, etc.) or near materials (curtains, draperies) that may block the ventilation holes. When internal heat builds up due to blockage of ventilation holes, the temperature sensor will function, and the power will be turned off automatically.
- Leave space of more than 30 cm (11 ⁷/₈ inches) around the unit.
- Be careful not to allow the ventilation holes to inhale tiny objects such as pieces of paper or clumps of dust.

Hot and humid

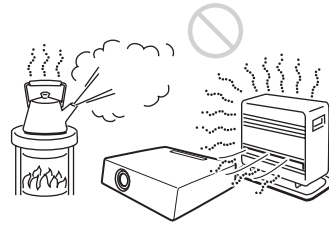

- Avoid installing the unit in a location where the temperature or humidity is very high, or the temperature is very low.
- To avoid moisture condensation, do not install the unit in a location where the temperature may rise rapidly.

Locations subject to direct cool or warm air from an air-conditioner

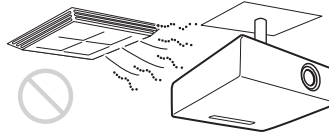

Installing the projector in such a location may cause a malfunction of the unit due to moisture condensation or a rise in temperature.

Near a heat or smoke sensor

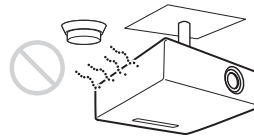

Malfunction of the sensor may occur.

Very dusty, extremely smoky locations

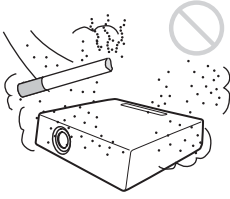

Avoid installing the unit in a very dusty or extremely smoky environment. Otherwise, the air filter will become obstructed, and this may cause a malfunction of the unit or damage it. Dust preventing the air passing through the filter may cause a rise in the internal temperature of the unit. Clean the filter periodically.

Unsuitable Conditions

Do not use the projector under the following conditions.

Standing the unit upright on one side

Avoid using the unit standing upright on its side. It may cause malfunction.

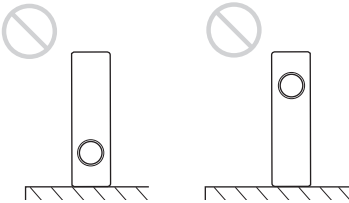

Tilting the unit to the right or left

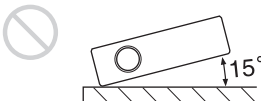

Avoid tilting the unit to an angle of 15°, and avoid installing the unit in any way other than placing it on a level surface or suspending from the ceiling. Such an installation may cause color shading or shorten the lamp life excessively.

Blocking the ventilation holes

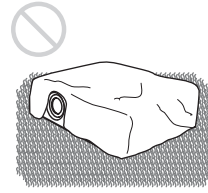

Avoid using a thick-piled carpet or anything that covers the ventilation holes (exhaust/intake); otherwise, internal heat may build up.

Placing a blocking object just in front of the lens

Do not place any object just in front of the lens that may block the light during projection. Heat from the light may damage the object. Use the PIC MUTING key on the Remote Commander to cut off the picture.

Usage at High Altitude

When using the projector at an altitude of 1,500 m or higher, turn on “High Altitude Mode” in the INSTALL SETTING menu. Failing to set this mode when using the projector at high altitudes could have adverse effects, such as reducing the reliability of certain components.

Note on carrying the projector

The unit is manufactured using high-precision technology. When transporting the unit stored in the carrying case, do not drop the unit or subject it to shock, as this may cause damage. When storing the unit in the carrying case, disconnect the AC power cord and all other connecting cables or cards, and store the supplied accessories in a pocket of the carrying case.

Note on the screen

When using a screen with an uneven surface, a striped pattern may rarely appear on the screen depending on the distance between the screen and the projector or the zooming magnification settings used. This is not a malfunction of the projector.

Features

High brightness, high picture quality

High brightness

Adopting Sony's unique optical system that provides a high-efficiency optical system. It allows the 165 W lamp to give a light output of 2000 ANSI lumen.

High picture quality

VPL-ES3: Three super-high-aperture 0.63-inch SVGA panels with approximately 480,000 effective pixels, produce a resolution of 800 × 600 dots (horizontal/vertical) for RGB input, and 500 horizontal TV lines for video input.

VPL-EX3: Three super-high-aperture 0.63-inch XGA panels with approximately 790,000 effective pixels, produce a resolution of 1024 × 768 dots (horizontal/vertical) for RGB input, and 750 horizontal TV lines for video input.

Quiet presentation environment

Low fan noise reduces distraction allowing you to run an optimum presentation even in a quiet environment.

Short focal lens

The projection distance is very short, approximately 2.3 m (7.5 feet), when projecting an 80-inch image, which allows projection on a larger screen even in a limited space.

Security Functions

Security lock

This function makes it possible to prevent projection of a picture on the screen unless the required password is entered when the projector is turned on.

Panel key lock

This function locks all the keys on the control panel of the projector, allowing use of the keys on the Remote Commander. This

prevents the projector from operating incorrectly.

About Trademarks

- Adobe Acrobat is a trademark of Adobe Systems Incorporated.
- Windows is a registered trademark of Microsoft Corporation in the United States and/or other countries.
- VGA, SVGA, XGA and SXGA are registered trademarks of the International Business Machines Corporation, U.S.A.
- Kensington is a registered trademark of Kensington Technology Group.
- Macintosh is a registered trademark of Apple Computer, Inc.
- VESA is a registered trademark of the Video Electronics Standard Association.
- Display Data Channel is a trademark of the Video Electronics Standard Association.

Location and Function of Controls

Top/Right Side/Front

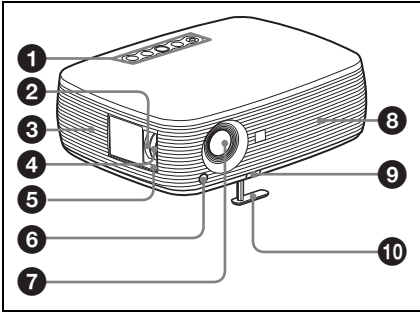

Rear/Bottom

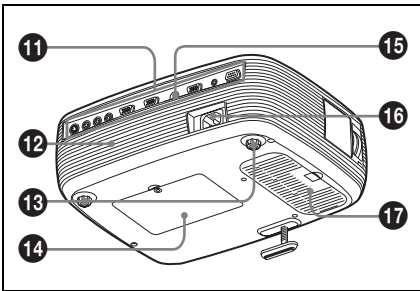

1 Control panel

For details, see “Control Panel” on page 10.

2 Zoom ring

Adjusts the picture size.

3 Ventilation holes (intake)

4 Focus ring

Adjusts the picture focus.

5 Security lock

Connects to an optional security cable (from Kensington).
Web page address:
<http://www.kensington.com/>

6 Front remote control detector

7 Lens

Remove the lens cover before projection.

8 Ventilation holes (exhaust)

9 Adjuster adjustment button

For details, see “Using the adjuster” on page 17.

10 Adjuster

11 Connector Panel

For details, see “Connector Panel” on page 11.

12 Speaker

13 Adjusters (hind pad)

14 Lamp cover

15 Rear remote control detector

16 AC IN socket

Connects the supplied AC power cord.

17 Ventilation holes (intake)/Air filter cover

Notes

- Do not place anything near the ventilation holes as this may cause internal heat build-up.
- Do not place your hand near the ventilation holes as this may cause injury.
- To maintain optimal performance, **clean the air filter every 500 hours.**

For details, see “Cleaning the Air Filter” on page 36.

Control Panel

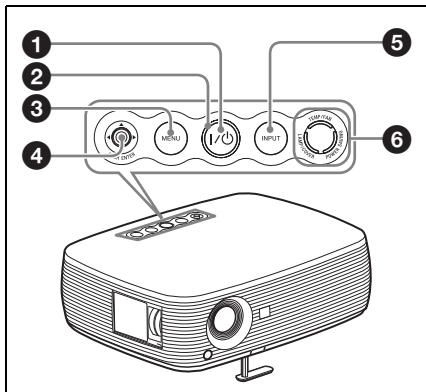

1 I/⏻ (On/Standby) key

Turns on the projector when the projector is in standby mode. The ON/STANDBY indicator around the I/⏻ key flashes in green until the projector is ready to operate.

2 ON/STANDBY indicator (located around the I/⏻ key)

Lights up or flashes under the following conditions:

- Lights in red when the AC power cord is plugged into a wall outlet. Once the projector is in standby mode, you can turn it on with the I/⏻ key.
- Lights in green when the power is turned on, and when it is ready to operate.
- Flashes in green from the projector is turned on until the projector is ready to operate. Also, flashes in green while the cooling fan is running after the power is turned off with the I/⏻ key. The fan runs for about 90 seconds after the power is turned off.

For detail on the I/⏻ indicator, see page 18.

3 MENU key

Displays the on-screen menu. Press again to clear the menu.

4 PUSH ENTER/▲/▼/◀/▶ (Arrow) keys

Used to enter the settings of items in the menu system, select a menu, or make various adjustments.

5 INPUT key

6 Status indicators

• POWER SAVING

Lights when the projector is in power saving mode.

• TEMP (Temperature)/FAN

Lights or flashes under the following conditions:

- Lights when the temperature inside the projector becomes unusually high.
- Flashes when the fan is broken.

• LAMP/COVER

Lights or flashes under the following conditions:

- Lights when the lamp has reached the end of its life or reaches a high temperature.
- Flashes when the lamp cover or air filter cover is not secured firmly.

For details, see page 39.

Connector Panel

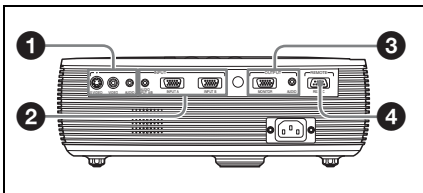

1 VIDEO INPUT connector

- **S VIDEO (mini DIN 4-pin):** Connects to the S video output (Y/C video output) of video equipment.
- **VIDEO (phono type):** Connects to the composite video output of video equipment.
- **AUDIO jack (stereo minijack):** To listen to sound output from video equipment, connect via this jack to the audio output of the video equipment.

To listen to sound output from a computer with the VPL-ES3, connect via this jack to the audio output of the computer.

2 INPUT connector

- **AUDIO INPUT A/B jack (stereo minijack) (for VPL-EX3 only):** To listen to sound output from a computer, connect via this jack to the audio output of the computer. (common INPUT A/B)
- **INPUT A (HD D-sub 15-pin, female):** Inputs a computer signal, video GBR signal, component signal, or DTV signal depending on the connected equipment. Connects to the output connector of equipment using the supplied cable or an optional cable.

For details, see “Connecting a Computer” on page 14 and “Connecting a VCR” on page 15.

- **INPUT B connector (HD D-sub 15-pin) (for VPL-EX3 only):** Connect to external equipment such as a computer. Connect to the monitor output of a computer.

3 OUTPUT connector

- **MONITOR (HD D-sub 15-pin, female):** Connect to the video input connector of the monitor. Outputs signals from the selected channel and computer signals only from among the signals from the INPUT A or INPUT B (VPL-EX3 only).
- **AUDIO (stereo minijack):** Connects to external active speakers. The volume of the speakers can be controlled by the VOLUME +/- keys on the Remote Commander.

For the VPL-EX3, when INPUT A or INPUT B is selected, the sound input to the AUDIO (AUDIO INPUT A/B) connector which is common for INPUT A/B is output.

When VIDEO or S VIDEO is selected, the sound input to the AUDIO input connector of VIDEO IN is output.

4 RS-232C connector (D-sub 9-pin, female)

Connects to a computer to operate the projector from the computer.

Remote Commander

The keys that have the same names as those on the control panel function identically.

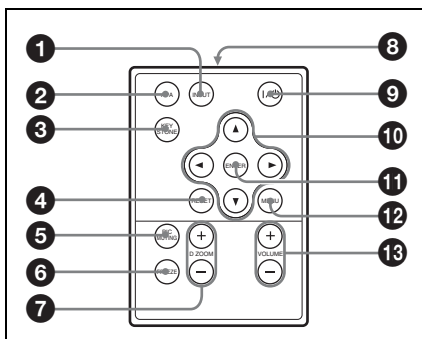

1 INPUT key

2 APA (Auto Pixel Alignment) key

Automatically adjusts a picture to its clearest while a signal is input from a computer.

For details, see “Smart APA” in “The SET SETTING Menu” on page 28.

3 KEYSTONE (Trapezoidal distortion correction) key

Adjusts the vertical trapezoidal distortion of the image. Pressing this key, the adjustment menu are displayed. Use the arrow keys (▲▼/◀▶) for adjustment.

4 RESET key

Resets the value of an item to its factory preset value or returns the enlarged image to its original size. This key functions when the menu or a setting item is displayed on the screen.

5 PIC MUTING key

Cuts off the picture. Press again to restore the picture.

6 FREEZE key

Freezes the projected picture. To cancel the frozen picture, press the key again.

7 D ZOOM (Digital Zoom) +/- key

Enlarges the image at a desired location on the screen.

8 Infrared transmitter

9 I/⏻ (On/Standby) key

10 ▲▼/◀▶ (Arrow) keys

11 ENTER key

12 MENU key

13 VOLUME +/- keys

Before using the Remote Commander

Pull out the clear film from the lithium battery holder.

To replace a battery

- 1 Release the lock of the lithium battery holder by picking it, and pull out the holder from the Remote Commander.

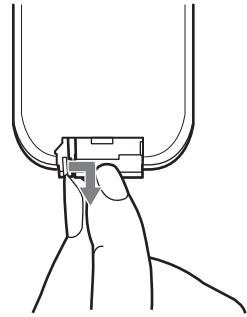

- 2 Install the lithium battery.

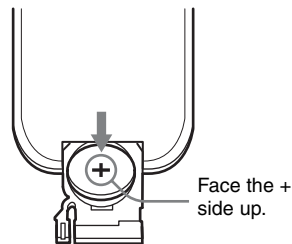

- 3 Put the lithium battery holder back into the Remote Commander.

Notes on the lithium battery

- A button type lithium battery (CR2025) is used in the Remote Commander. Do not use batteries other than CR2025.
- Keep the lithium battery out of the reach of children.
- Should the battery be swallowed, immediately consult a doctor.

Notes on Remote Commander operation

- Make sure that nothing obstructs the infrared beam between the Remote Commander and the remote control detector on the projector. Direct the Remote Commander toward the remote control detector.
- The operation range is limited. The shorter the distance between the Remote Commander and the remote control detector is, the wider the angle within which the commander can control the projector becomes.

Installing the Projector

The distance between the lens and the screen varies depending on the size of the screen. Use the following table as a guide.

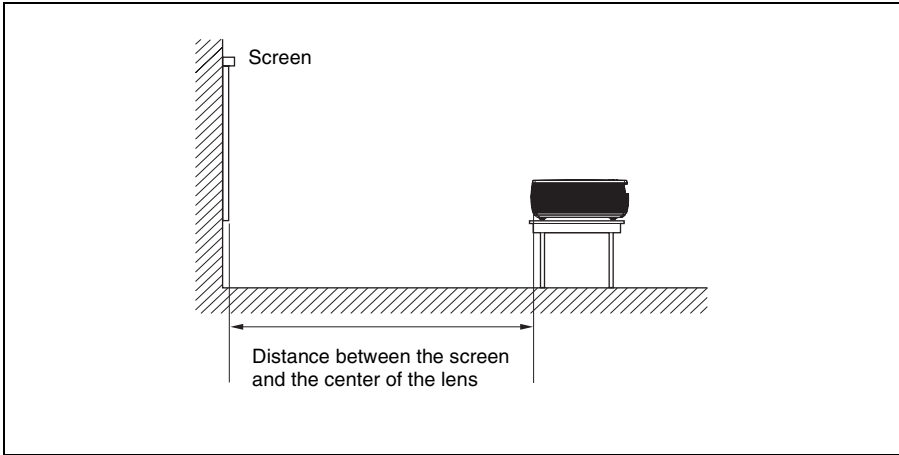

Projecting the Picture

Unit: m (feet)

Screen size (inches)	40	80	100	150	200	250	300
Minimum Distance	1.2 (3.9)	2.3 (7.5)	2.9 (9.5)	4.4 (14.4)	5.9 (19.4)	7.3 (24)	8.8 (28.9)
Maximum Distance	1.4 (4.6)	2.8 (9.2)	3.6 (11.8)	5.4 (17.7)	7.2 (23.6)	9.0 (29.5)	10.7 (35.1)

There may be a slight difference between the actual value and the design value shown in the table above.

For details on installation diagram, see “Installation Diagram” on page 46.

Connecting the Projector

When you connect the projector, make sure to:

- Turn off all equipment before making any connections.
- Use the proper cables for each connection.
- Insert the cable plugs firmly; loose connections may increase noise and reduce performance of picture signals. When pulling out a cable, be sure to pull it out by the plug, not the cable itself.

Connecting a Computer

This section describes how to connect the projector to a computer. For more information, refer to the computer's instruction manual.

To connect a computer

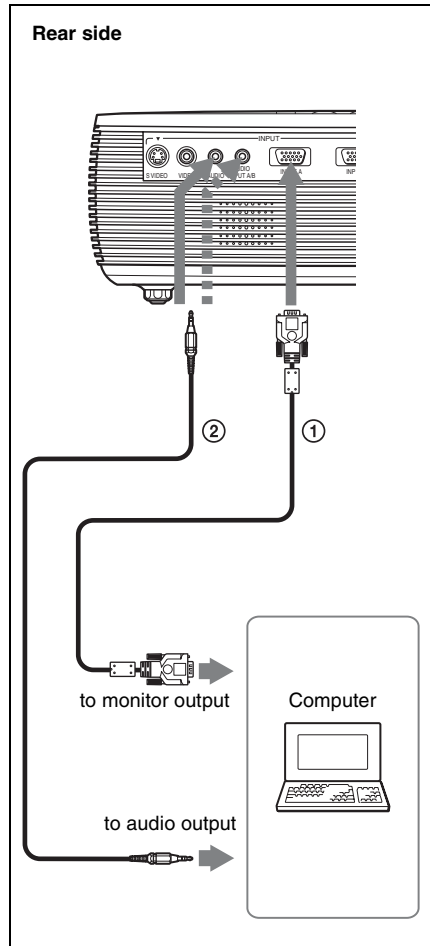

- ① HD D-sub 15-pin cable (supplied)
- ② Stereo audio connecting cable (not supplied)
(Use a no-resistance cable.)

Notes

- For stereo audio connection, connect the stereo audio connecting cable to the AUDIO connector for VPL-ES3, or to the AUDIO INPUT A/B connector for VPL-EX3.
- The projector accepts VGA, SVGA, XGA, SXGA, and SXGA+ signals. However, we recommend that you set the output mode of your computer to SVGA (VPL-ES3) or XGA (VPL-EX3) mode for the external monitor.
- If you set your computer, such as a notebook computer, to output the signal to both your

computer's display and the external monitor, the picture of the external monitor may not appear properly. Set your computer to output the signal to only the external monitor.

For details, refer to the operating instructions supplied with your computer.

Note

To connect a Macintosh computer equipped with a video output connector of a type having two rows of pins, use a commercially available plug adaptor.

Connecting a VCR

This section describes how to connect the projector to a VCR.

For more information, refer to the instruction manuals of the equipment you are connecting.

To connect to a video or S video output connector

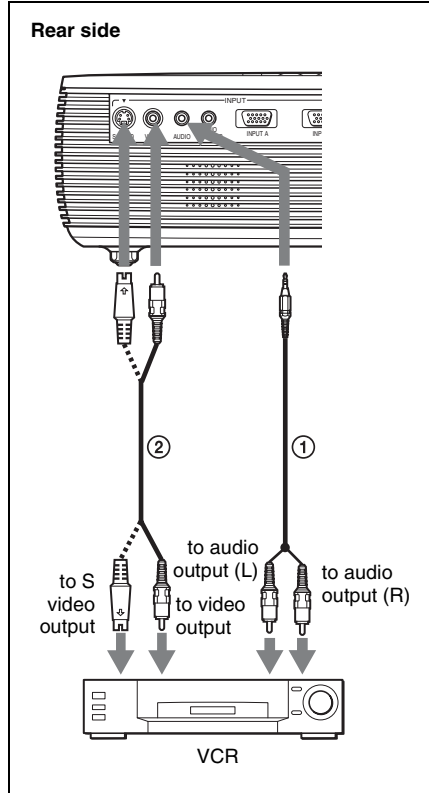

- ① Stereo audio connecting cable (not supplied) (Use a no-resistance cable.)
- ② Video cable (not supplied) or S-Video cable (not supplied)

To connect to a video GBR/ Component output connector

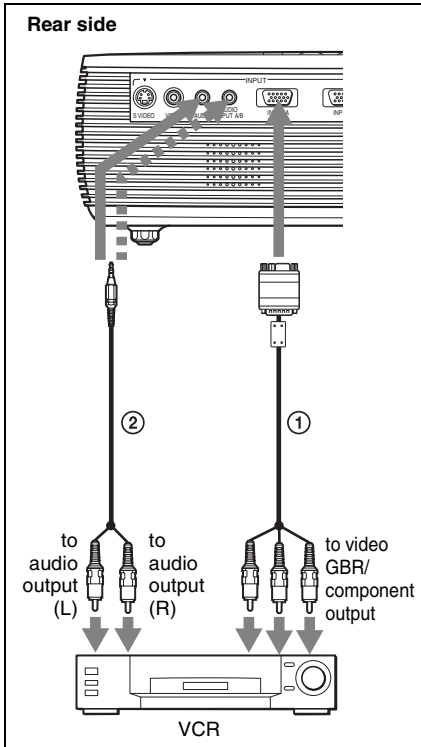

- ① Signal Cable (not supplied)
HD D-sub 15-pin (male) ↔ 3 × phono jack
- ② Stereo audio connecting cable (not supplied)
(Use a no-resistance cable.)

Notes

- For stereo audio connection, connect the stereo audio connecting cable to the AUDIO connector for VPL-ES3, or to the AUDIO INPUT A/B connector for VPL-EX3.
- Set the aspect ratio using “Wide Mode” on the INPUT SETTING menu according to the input signal.
- When you connect the projector to a video GBR output connector, select “Video GBR” or when you connect the projector to a component output connector, select “Component” with the “Input-A Signal Sel.” setting on the SET SETTING menu.
- Use the composite sync signal when you input the external sync signal from video GBR/component equipment.

Projecting

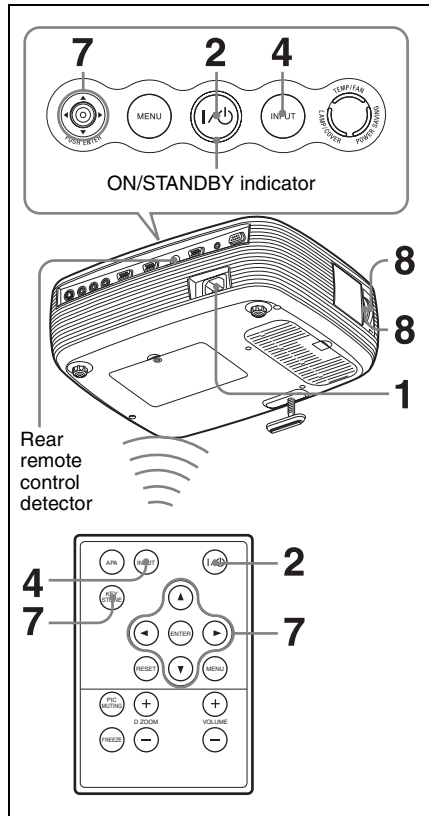

- 1 Plug the AC power cord into a wall outlet, and connect all equipment, then remove the lens cover.
The ON/STANDBY indicator lights in red and the projector goes into standby mode.
- 2 Press the I/O key.
The ON/STANDBY indicator lights after flashing in green. The projector cannot be used while the ON/STANDBY indicator is flashing.
- 3 Turn on the equipment connected to the projector.

- 4** Press the INPUT key to select the input source.
Each time you press the key, the input signal switches as follows:

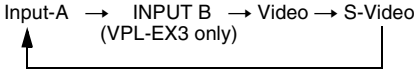

To input from	Press INPUT to display
Computer/Component connected to the INPUT A connector	Input-A
Computer connected to the INPUT B connector	Input-B
Video equipment connected to the VIDEO input connector	Video
Video equipment connected to the S VIDEO input connector	S-Video



Smart APA (Auto Pixel Alignment) adjusts the picture of the connected equipment so that it is projected clearly.

Notes

- If “Auto Input Search” is set to “On,” the projector searches for the signals from the connected equipment and displays the input channel where the input signals are found.

For details, see “Auto Input Search” on page 28.

- The Smart APA feature is effective for the input signal from a computer only.

- 5** Switch the equipment connected to output to the projector.
Depending on the type of your computer, for example a notebook, or an all-in-one LCD type, you may have to switch the computer to output to the projector by pressing certain keys (e.g., , , etc.), or by changing your computer’s settings.

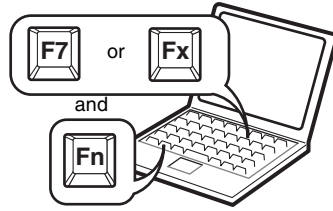

Note

The key used for switching the computer to output to the projector varies depending on the type of computer.

- 6** Adjust the upper or lower position of the picture.
Use the adjuster to adjust the picture position.



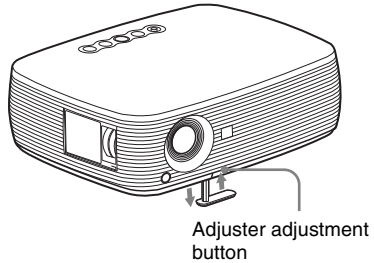

Using the adjuster

Lift the projector while pressing the adjuster adjustment button, and adjust the tilt of the projector, then release the button to lock the adjuster.



Notes

- Be careful not to let the projector down on your fingers.
- Do not push hard on the top of the projector with the adjuster out. It may be occurred malfunction.

- 7** Adjust the trapezoidal distortion () of the picture. Press the KEYSTONE key on the Remote Commander to display the adjustment menu and adjust the tilt using the /// keys.

- 8** Adjust the size of the picture and the focus.
Adjust the picture size using the Zoom ring and adjust the picture focus using the Focus ring.

Turning Off the Power

- 1** Press the I/⏻ key.
“POWER OFF? Please press I/⏻ key again.” appears to confirm that you want to turn off the power.

Note

The message disappears if you press any key other than the I/⏻ key, or if you do not press any key for five seconds.

- 2** Press the I/⏻ key again.
The ON/STANDBY indicator flashes in green and the fan continues to run to reduce the internal heat. Also, the ON/STANDBY indicator flashes quickly for the first 45 seconds. During this time, you will not be able to light up the ON/STANDBY indicator again with the I/⏻ key.
- 3** Unplug the AC power cord from the wall outlet after the fan stops running and the ON/STANDBY indicator lights in red.

Note

Do not unplug the AC cord while the fan is still running; otherwise, the fan will stop even though the internal heat is still high, which could result in a breakdown of the projector.

Selecting the Menu Language

You can select one of fifteen languages for displaying the menu and other on-screen displays. The factory setting is English. To change the menu language, proceed as follows:

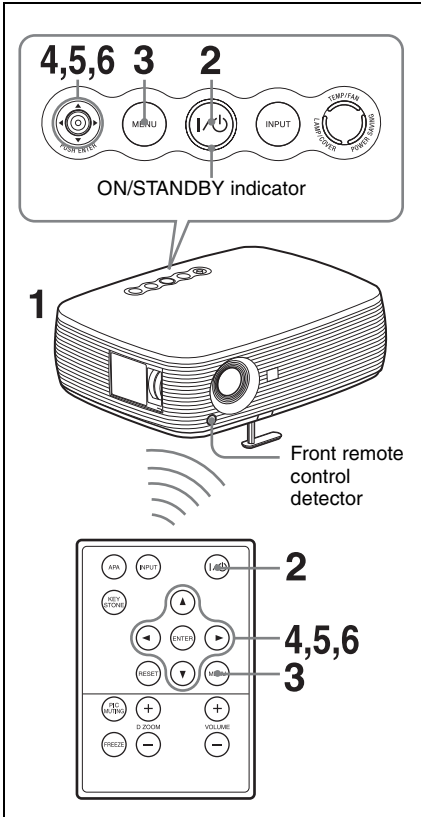

- 1** Plug the AC power cord into a wall outlet.
- 2** Press the I/⏻ key to turn on the projector.
- 3** Press the MENU key. The menu appears. The menu currently selected is shown as a yellow button.

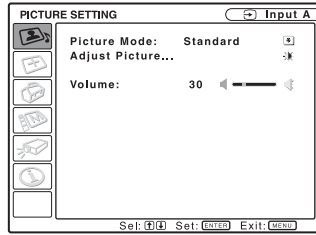

- 4** Press the ▲ or ▼ key to select the MENU SETTING menu, then press the ► or ENTER key. The selected menu appears.

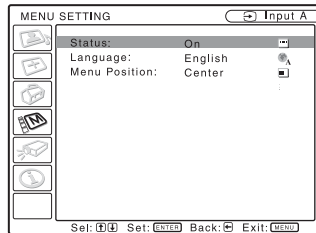

- 5** Press the ▲ or ▼ key to select "Language," then press the ► or ENTER key.

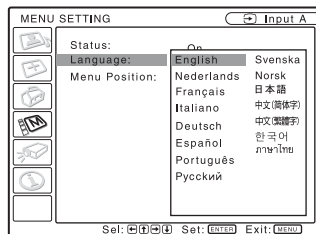

- 6** Press the ▲, ▼, ◀ or ▶ key to select a language, then press the ENTER key. The menu changes to the selected language.

To clear the menu

Press the MENU key.

The menu disappears automatically if a key is not pressed for one minute.

Security Lock

The projector is equipped with a security lock function. When you turn the power of the projector on, you are required to input the previously set password. If you do not input the correct password, you will not be able to project the picture.

Note

You will not be able to use the projector if you forget your password and the password administrator is not available. Be please aware that using the security lock can prevent valid usage in such cases.

To use the security lock

- 1 Press the MENU key and then, on the INSTALL SETTING menu, turn on the “Security Lock” setting.
- 2 Enter the password.
Use the MENU, ◀/▶/▲/▼, and ENTER keys to enter the four-digit password. (The default initial password setting is “ENTER, ENTER, ENTER, ENTER.” After this is entered you can put in your own password. Therefore, when you use this function for the first time, please input “ENTER” four times.)

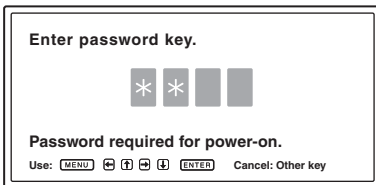

Next, the screen for entering the new password is displayed. (Enter the password on this screen even if you want to keep the current password.)

Enter the password on this screen.

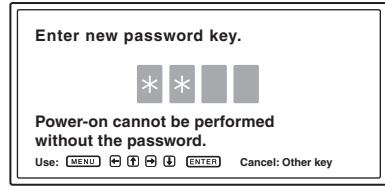

- 3 Enter the password again to confirm.

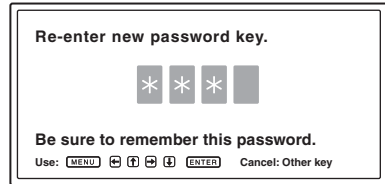

When the following message is displayed, the setting for security lock is completed.

Security Lock enabled!

If “Invalid Password!” is displayed on the screen, perform this procedure again from step 1.

Invalid Password!

- 4 Turn the main power off and disconnect the AC power cord.
The security lock is set to on, then it becomes effective. The screen used for entering the password is displayed when the power is turned on the next time.

Security certification

When the password screen is displayed, enter the password that was set. If you fail to enter the correct password after three tries, the projector cannot be used. In this case, press the I/O key to turn off the power.

To cancel the security lock

- 1 Press the MENU key, then turn off the “Security Lock” setting on the INSTALL SETTING menu.

- 2** Enter the password.
Enter the password that was set.

Note

If you call the customer service center because you have forgotten the password, you will need to be able to verify the projector's serial number and your identity. (This process may differ in other countries/regions.) Once your identity has been confirmed, we will provide you with the password.

Effective Tools for Your Presentation

To enlarge the image (Digital Zoom function)

You can select a section of the image to enlarge. This function works when a signal from a computer is input. This function does not work when a video signal is input.

- 1** Project a normal image, and press the D ZOOM + key on the Remote Commander.

The digital zoom icon appears in the center of the image.

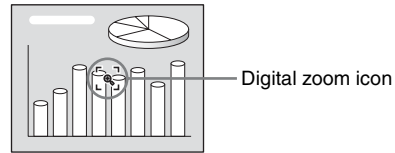

- 2** Move the icon to the point on the image you want to enlarge. Use the arrow key (▲/▼/◀/▶) to move the icon.

- 3** Press the D ZOOM + key again.
The portion of the image where the icon is located is enlarged. The enlargement ratio is displayed on the screen for a few seconds.

By pressing the + key repeatedly, the image size (ratio of enlargement: max. 4 times) increases.

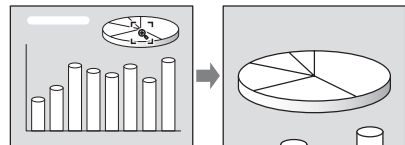

Use the arrow key (▲/▼/◀/▶) to scroll the enlarged image.

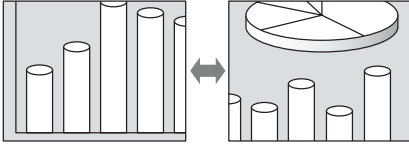

To return the image to its original size

Press the D ZOOM – key.

Just pressing the RESET key returns the image back to its original size immediately.

To freeze the image projected (Freeze function)

Press the FREEZE key. “Freeze” appears when the key is pressed. This function works when a signal from a computer is input.

To restore the original screen, press the FREEZE key again.

Using a MENU

The projector is equipped with an on-screen menu for making various adjustments and settings.

Display items

Input signal indicator

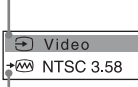

Input signal setting indicator

Picture adjustment menu



Input signal indicator

Shows the selected input channel. x(→) is displayed when no signal is input. You can hide this indicator using “Status” on the MENU SETTING menu.

Input signal setting indicator

For Input-A: Shows “Auto.”

For Video/S-Video input: Shows “Auto” or the “Color System” setting on the SET SETTING menu.

- 1 Press the MENU key.
The menu appears.
The menu presently selected is shown as a yellow button in the column on the left.

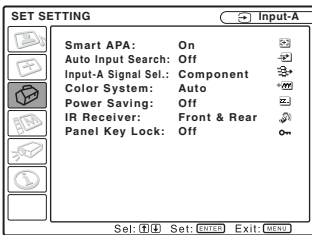

- 2 Use the ▲ or ▼ key to select a menu, then press the ► or ENTER key.
The selected menu appears.

- 3 Select an item.
Use the ▲ or ▼ key to select the item, then press the ► or ENTER key.
The setting items are displayed in a pop-up menu or in a sub menu.

Pop-up menu

Menu Setting items Selected input signal

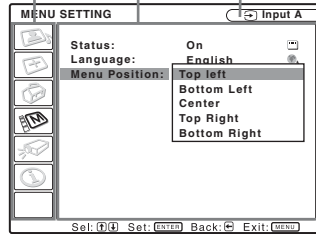

Sub menu

Menu Setting items

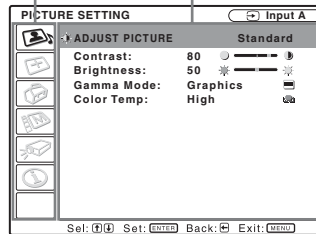

- 4 Make the setting or adjustment of an item.
 - **When changing the adjustment level:**
To increase the number, press the ▲ or ► key.
To decrease the number, press the ▼ or ◀ key.
Press the ENTER key to restore the previous screen.
 - **When changing the setting:**
Press the ▲ or ▼ key to change the setting.
Press the ENTER or ◀ key to restore the previous screen.

To clear the menu

Press the MENU key.

The menu disappears automatically if a key is not pressed for one minute.

To reset items that have been adjusted

Select the item that you want to reset, and then press the RESET key on the Remote Commander.

“Complete!” appears on the screen and **the setting of the item that you have selected is factory preset values.**

Storage of the settings

The settings are automatically stored in the projector memory except the settings for items (“Dot Phase,” “H Size” and “Shift” etc.) in the “Adjust Signal...” and the “Color System” when the ENTER key is pressed.

If no signal is input

If there is no input signal, “Cannot adjust this item.” appears on the screen.

Unadjustable items

Items that cannot be adjusted, depending on the input signal, are not displayed on the menu.

For details, see page 33.

The PICTURE SETTING Menu

The PICTURE SETTING menu is used for adjusting the picture or volume. Items that can be adjusted or set depend on the kind of input signals. For details, see “Input signals and adjustable/setting items” on page 33.

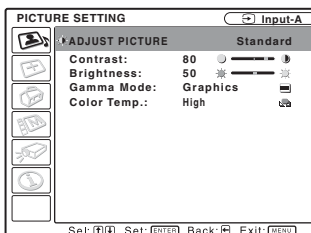
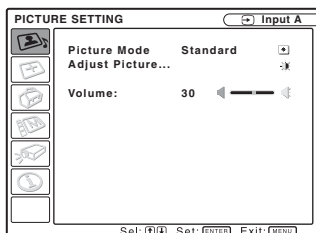

Setting items	Functions	Initial setting
Picture Mode	<p>Selects the picture mode.</p> <ul style="list-style-type: none"> • Dynamic: Emphasizes the contrast to produce a “dynamic” picture. • Standard: Normally select this setting. If the picture has roughness with the “Dynamic” setting, this setting reduces the roughness. • Game: Select for viewing game picture. • Living: Select for viewing sports, music, digital video camera picture. • Cinema: Select for viewing film-like picture. • Presentation: Select for viewing presentation files 	Standard
Adjust Picture...	The unit can store the setting values of the following sub menu items for each picture mode separately.	
Contrast	Adjusts the picture contrast.	80
Brightness	Adjusts the picture brightness.	50
Color	Adjusts color intensity.	50
Hue	Adjusts color tones. The higher the setting, the more greenish the picture becomes. The lower the setting, the more purplish.	50
Sharpness	Adjusts the sharpness.	30
Gamma Mode	<p>Selects a gamma correction curve.</p> <ul style="list-style-type: none"> • Graphics: Improves the reproduction of halftones. Photos can be reproduced in natural tones. • Text: Contrasts black and white. Suitable for images that contain lots of text. 	Graphics
Color Temp.	<p>Adjusts the color temperature.</p> <ul style="list-style-type: none"> • High: Makes white colors bluish. • Low: Makes white colors reddish. 	Set according to the input signal
Volume	Adjusts the volume.	30

The INPUT SETTING Menu

The INPUT SETTING menu is used to adjust the input signal.

Items that can be adjusted or set depend on the kind of input signals. For details, see “Input signals and adjustable/setting items” on page 33.

When the video signal is input

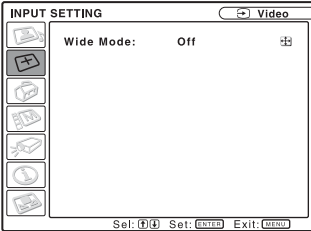

Setting items	Functions	Initial setting
Wide Mode	Sets the aspect ratio of the picture. <ul style="list-style-type: none"> • Off: When a picture with a ratio of 4:3 is input. • On: When a picture with a ratio of 16:9 (squeezed) is input from a DVD player. 	Off

When the signal is input from a computer

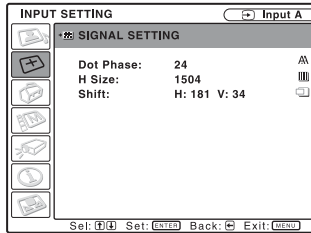
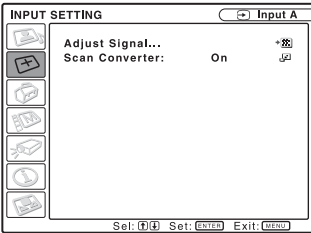

Setting items	Functions	Initial setting
Adjust Signal...		
Dot Phase	Adjusts the dot phase of the LCD panel and the signal output from a computer. Adjust the picture further for finer picture after the picture is adjusted by pressing the APA key.	Set according to the input signal
H Size	Adjusts the horizontal size of a picture output from a computer. Adjust the setting according to the dots of the input signal. For details, see page 44.	Set according to the input signal

Setting items	Functions	Initial setting
Shift	Adjusts the position of the picture. H adjusts the horizontal position of the picture. V adjusts the vertical position of the picture. As the setting for H increases, the picture moves to the right, and as the setting decreases, the picture moves to the left. As the setting for V increases, the picture moves up, and as the setting decreases, the picture moves down. Use the ◀ or the ▶ key to adjust the horizontal position and the ▲ and ▼ key for the vertical position.	Set according to the input signal
Scan Converter	Converts the signal to display the picture according to the screen size. When set to “Off,” displays the picture while matching one pixel of input picture element to that of the LCD. The picture will be clear but the picture size will be smaller.	On

Note

Note that if the projector is used for profit or for public viewing, modifying the original picture by switching to the wide mode may constitute an infringement of the rights of authors or producers, which are legally protected.

About the Preset Memory No.

This projector has 40 types of preset data for input signals (the preset memory). When a preset signal is input, the projector automatically detects the signal type and recalls the data for the signal from the preset memory to adjust it to an optimum picture. The memory number and signal type of that signal are displayed on the INFORMATION menu (See page 32). You can also adjust the preset data through the INPUT SETTING menu.

See the chart on page 44 to find if the signal is registered in the preset memory.

Note

When the aspect ratio of input signal is other than 4:3, a part of the screen is displayed in black.

The SET SETTING Menu

The SET SETTING menu is used for changing the settings of the projector.

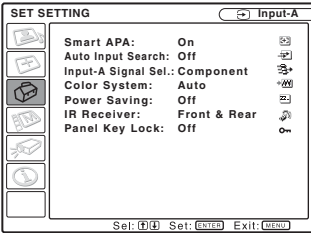

Setting items	Functions	Initial setting
Smart APA	<p>The APA (Auto Pixel Alignment) automatically adjusts “Dot Phase,” “H Size” and “Shift” on the INPUT SETTING menu for the input signal from a computer.</p> <ul style="list-style-type: none"> • On: When a signal is input from a computer, the APA functions automatically so that the picture can be seen clearly. Once the specified input signal has been adjusted by the “Smart APA,” it will not be readjusted even when the cable is disconnected and connected again or the input channel is changed. You can adjust the picture by pressing the APA key on the Remote Commander even if “Smart APA” set to “On.” • Off: The APA functions when you press the APA key on the Remote Commander. 	On
Auto Input Search	When set to “On,” the projector detects input signals in the following order: Input-A/Input-B (VPL-EX3 only)/Video/S-Video. It indicates the input channel when the power is turned on or the INPUT key is pressed.	Off
Input-A Signal Sel.	<p>Selects the “Component” or “Video GBR” signal input via the INPUT A channel.</p> <p>When a signal is input from a computer, this item is not displayed on the screen because this unit automatically recognizes the signal.</p>	Component
Color System	<p>Selects the color system of the input signal.</p> <p>If you select “Auto,” the projector detects the color system of the input signal automatically. If the picture is distorted or colorless, select the color system according to the input signal.</p> <p>Whenever the computer starts, the color system is set to “Auto.”</p>	Auto
Power Saving	When set to “On,” the projector goes into power saving mode if no signal is input for 10 minutes. Although the lamp goes out, the cooling fan keeps running. The power saving mode is canceled when a signal is input or any key is pressed. In power saving mode, no keys function for the first 45 seconds after the lamp goes out.	Off

Setting items	Functions	Initial setting
IR Receiver	<p>Selects the remote control detectors (IR Receiver) on the front and rear of the projector.</p> <ul style="list-style-type: none"> • Front & Rear: Activates both the front and rear detectors. • Front: Activates the front detector only. • Rear: Activates the rear detector only. 	Front & Rear
Panel Key Lock	<p>Locks all the control panel keys on the top panel of the projector so that the projector can be operated only with the Remote Commander.</p> <p>To lock the control panel keys, set to “On.”</p> <p>When it is set to “On,” keeping the I/⏻ key on the control panel pressed for 10 seconds turns the projector on when it is in standby mode, and turns the projector to standby mode when the power is on. If you press and hold the MENU key for about 10 seconds when the power is on, the lock will be released and “Panel Key Lock” is automatically set to “Off.”</p>	Off

Notes

- Press the APA key when the full image is displayed on the screen. If the projected image includes a black portion around it, the APA function will not work properly and some parts of the image may not be displayed on the screen.
- You can cancel the adjustment by pressing the APA key again while “Adjusting” appears on the screen.
- The picture may not be adjusted properly depending on the type of input signal.
- Adjust the “Dot Phase,” “H Size,” and “Shift” items on the INPUT SETTING menu when you adjust the picture manually.

The MENU SETTING Menu

The MENU SETTING menu is used for changing the menu displays.

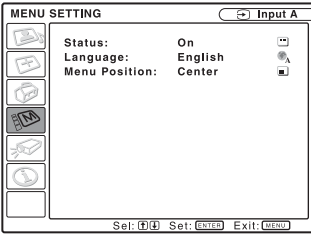

Setting items	Functions	Initial setting
Status (on-screen display)	Sets up the on-screen display. When set to “Off,” turns off the on-screen displays except for the menus, a message when the power is turned off, and warning messages.	On
Language	Selects the language used in the menu and on-screen displays. The languages available are: English, Nederlands, Français, Italiano, Deutsch, Español, Português, Русский, Svenska, Norsk, 日本語, 中文(简体字), 中文(繁體字), 한국어 and ภาษาไทย.	English
Menu Position	Selects the display position of the menu from “Top Left,” “Bottom Left,” “Center,” “Top Right,” and “Bottom Right.”	Center

The INSTALL SETTING Menu

The INSTALL SETTING menu is used for changing the settings of the projector.

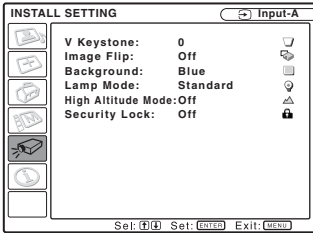

Setting items	Functions	Initial setting
V Keystone	Corrects the trapezoidal distortion caused by the projection angle using the ▲/▼/◀/▶ keys on the Remote Commander. When the bottom of the trapezoid is longer than the top ▲▼ : Sets a lower value. When the top of the trapezoid is longer than the bottom ◀▶ : Sets a higher value.	0
Image Flip	Flips the image on the screen horizontally and/or vertically. • Off : The image does not flip. • HV : Flips the image horizontally and vertically. • H : Flips the image horizontally. • V : Flips the image vertically.	Off
Background	Selects the background color of the screen when no signal is input to the projector. Select “Black” or “Blue.” Normally, set to “Blue.” This setting becomes effective when the menu is cleared after setting of the background color.	Blue
Lamp Mode	Sets the lamp brightness used during the projection. • High : Illuminates the projected image brightly. • Standard : Reduces fan noise and power consumption. The brightness of the projected image will be lower compared with the “High” setting.	Standard
High Altitude Mode	Set to “On” when the projector is used at an altitude of 1,500 m or higher.	Off
Security Lock	Turns on the projector’s security lock function. When set to “On,” turns on the security lock function, which locks the projector once a password has been set. <i>For details, see “Security Lock” on page 20.</i>	Off

The INFORMATION Menu

The INFORMATION menu displays the model name, serial number, the horizontal and vertical frequencies of the input signal and the cumulated hours of usage of the lamp.

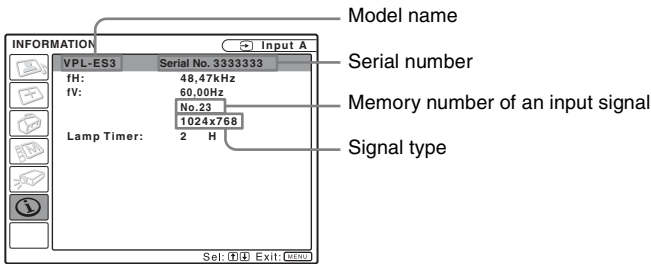

Setting items	Functions
fH	Displays the horizontal frequency of the input signal. The displayed value is approximate.
fV	Displays the vertical frequency of the input signal. The displayed value is approximate.
Lamp Timer	Indicates how long the lamp has been turned on.

Note

These are only displayed on the screen. You cannot alter the display, and these is no setting to be altered.

Input signals and adjustable/setting items

Adjust Picture... menu

Item	Input signal				
	Video or S-Video (Y/C)	Component	Video GBR	Computer	B&W
Picture Mode	●	●	●	●	●
Adjust Picture...					
Contrast	●	●	●	●	●
Brightness	●	●	●	●	●
Color	●	●	●	—	—
Hue	● (NTSC 3.58/4.43 only)	—	—	—	—
Sharpness	●	●	●	—	●
Gamma Mode	—	—	●*1	●	—
Color Temp.	●	●	●	●	●
Volume	●	●	●	●	●

● : Adjustable/can be set

— : Not adjustable/cannot be set

*1: Preset memory No. 3, 4 only

INPUT SETTING menu

Item	Input signal				
	Video or S-Video (Y/C)	Component	Video GBR	Computer	B&W
Adjust Signal...					
Dot Phase	—	—	—	●	—
H Size	—	—	—	●	—
Shift	—	●*1	●*1	●	—
Scan Converter	—	—	—	● (Lower than VGA for VPL- ES3 Lower than SVGA for VPL-EX3)	—
Wide Mode	●	●*2	●*2	—	●

● : Adjustable/can be set

— : Not adjustable/cannot be set

*1: Expect preset memory No. 3, 4

*2: Expect preset memory No. 7, 8, 9, 10, 11

Replacing the Lamp

The lamp used as a light source is consumable product. Thus replace the lamp with a new one in the following cases.

- When the lamp has burnt out or dims
- “Please replace the Lamp.” appears on the screen
- The LAMP/COVER indicator lights up

The lamp life varies depending on conditions of use.

Use an LMP-C162 Projector Lamp as the replacement lamp.

Use of any other lamps than the LMP-C162 may cause damage to the projector.

Caution

The lamp remains hot after the projector is turned off with the I/⏻ key. **If you touch the lamp, you may burn your finger. When you replace the lamp, wait for at least an hour for the lamp to cool.**

Notes

- **If the lamp breaks, consult with qualified personal.**
- Pull out the lamp by holding the handle. If you touch the lamp, you may be burned or injured.
- When removing the lamp, make sure it remains horizontal, then pull straight up. Do not tilt the lamp. If you pull out the lamp while it is tilted and if the lamp breaks, the pieces may scatter, causing injury.

- 1 Turn off the projector, and disconnect the AC power cord from the AC outlet.

Note

When replacing the lamp after using the projector, wait for at least an hour for the lamp to cool.

- 2 Place a protective sheet (cloth) beneath the projector. Turn the projector over so you can see its underside.

Note

Be sure that the projector is stable after turning it over.

- 3 Open the lamp cover by loosening the screw with a Phillips screwdriver.

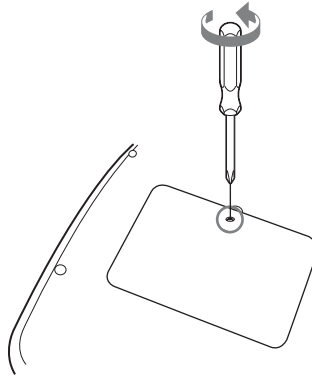

Note

For safety reasons, do not loosen any other screws.

- 4 Loosen the two screws on the lamp unit with the Phillips screwdriver (1). Fold out the handle (2), then pull out the lamp unit by the handle (3).

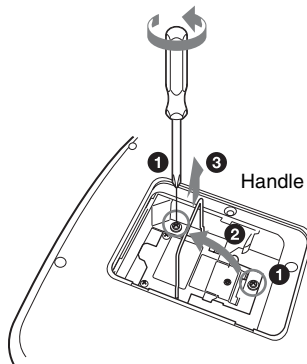

- 5 Insert the new lamp all the way in until it is securely in place (1). Tighten the two screws (2). Fold down the handle to replace it (3).

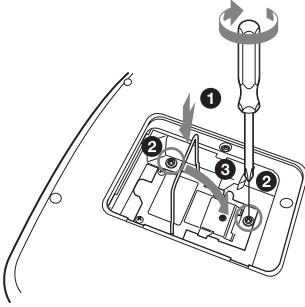

Notes

- Be careful not to touch the glass surface of the lamp.
- The power will not turn on if the lamp is not secured properly.

- 6 Close the lamp cover and tighten the screw.

Note

Be sure to attach the lamp cover securely as it was. If not, the projector cannot be turned on.

- 7 Turn the projector back over.
- 8 Connect the power cord.
The ON/STANDBY indicator around the I/⏻ key lights in red.
- 9 Press the following keys on the Remote Commander in the following order for less than five seconds each: RESET, ◀, ▶, ENTER.

Caution

Do not put your hands into the lamp replacement slot, and do not allow any liquid or other objects into the slot **to avoid electrical shock or fire.**

Disposal of the used lamp

For the customers in the USA

This product contains mercury. Disposal of this product may be regulated if sold in the United States. For disposal or recycling information, please contact your local authorities or the Electronics Industries Alliance (<http://www.eiae.org>).

Cleaning the Air Filter

The air filter should be cleaned every 500 hours. Remove dust from the outside of the ventilation holes with a vacuum cleaner. 500 hours are approximate. This value varies depending on the environment or how the projector is used.

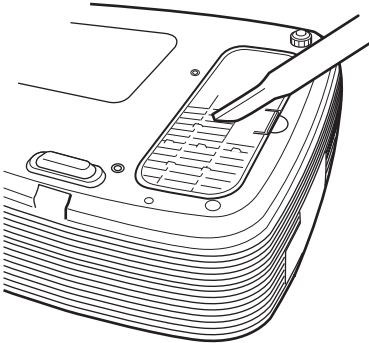

When it becomes difficult to remove the dust from the filter with a vacuum cleaner, remove the air filter and wash it.

- 1 Turn the power off and unplug the power cord.
- 2 Place a protective sheet (cloth) beneath the projector and turn the projector over.

Note

Be sure that the projector is stable after turning it over.

- 3 Remove the air filter cover.

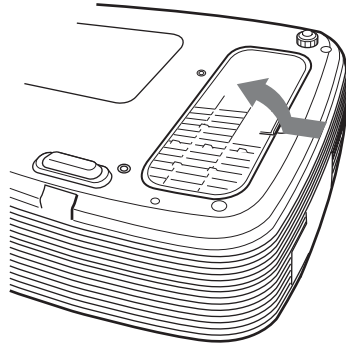

- 4 Remove the air filter.

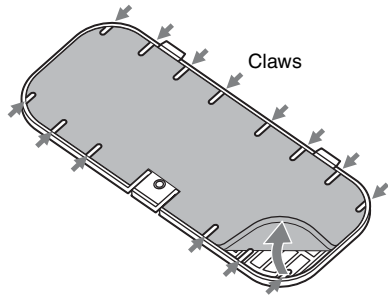

- 5 Wash the air filter with a mild detergent solution and dry it in a shaded place.
- 6 Attach the air filter so that it fits into the each claws (14 positions) on the air filter cover and replace the cover.

Notes

- If you neglect to clean the air filter, dust may accumulate, clogging it. As a result, the temperature may rise inside the unit, leading to a possible malfunction or fire.
- Be sure to attach the air filter cover firmly; the power can not be turned on if it is not closed securely.
- The air filter has a face and a reverse side. Place the air filter so that it fits in a notch on the air filter cover.
- To erase a message, press any key on the control panel of the projector or on the remote commander.

Troubleshooting

If the projector appears to be operating erratically, try to diagnose and correct the problem using the following instructions. If the problem persists, consult with qualified Sony personnel.

Power

Symptom	Cause and Remedy
The power is not turned on.	<ul style="list-style-type: none"> • The power has been turned off and on with the I/⏻ key at a short interval. → Wait for about 45 seconds before turning on the power (see page 18). • The lamp cover is not secured. → Close the lamp cover securely (see page 35). • The air filter cover is detached. → Attach the air filter cover securely (see page 36).
Both the LAMP/COVER and TEMP/FAN indicators light up.	<p>The electrical system has broken down. → Consult with qualified Sony personnel.</p>

Picture

Symptom	Cause and Remedy
No picture.	<ul style="list-style-type: none"> • A cable is disconnected or the connections are wrong. → Check that the proper connections have been made (see page 14). • The connections are wrong. → This projector is compatible with DDC2B (Digital Data Channel 2B). If your computer is compatible with DDC, turn the projector on according to the following procedures. <ol style="list-style-type: none"> 1 Connect the projector to the computer. 2 Turn the projector on. 3 Start the computer. • Input selection is incorrect. → Select the input source correctly using the INPUT key (see page 17). • The picture is muted. → Press the PIC MUTING key to release the picture muting (see page 12).
The picture is noisy.	<p>Noise may appear on the background depending on the combination of the number of dots input from the computer and the numbers of pixels on the LCD panel. → Change the desktop pattern on the connected computer.</p>
The picture from the INPUT A connector is colored strangely.	<p>The setting of “Input-A Signal Sel.” on the SET SETTING menu is incorrect. → Selects “Video GBR” or “Component” correctly according to the input signal (see page 28).</p>
On-screen display does not appear.	<p>“Status” on the MENU SETTING menu has been set to “Off.” → Set “Status” on the MENU SETTING menu to “On” (see page 30).</p>

Symptom	Cause and Remedy
Color balance is incorrect.	<ul style="list-style-type: none"> • The picture has not been adjusted properly. → Adjust the picture (see page 25). • The projector is set to the wrong color system. → Set “Color System” on the SET SETTING menu to match the color system being input (see page 28).
The picture is too dark.	<ul style="list-style-type: none"> • Contrast or brightness has not been adjusted properly. → Adjust the contrast or brightness on the “Adjust Picture...” menu properly (see page 25). • The lamp has burnt out or is dim. → Replace the lamp with a new one (see page 34).
The picture is not clear.	<ul style="list-style-type: none"> • The picture is out of focus. → Adjust the focus (see page 18). • Condensation has accumulated on the lens. → Leave the projector for about two hours with the power on.
The image extends beyond the screen.	<ul style="list-style-type: none"> • The APA key has been pressed even though there are black edges around the image. → Display the full image on the screen and press the APA key. → Adjust “Shift” on the INPUT SETTING menu properly (see page 27). • This input signal cannot be projected as the frequency is out of the acceptable range of the projector. → Input a signal that is within the range of the frequency. • The resolution setting of the output signal of the computer is too high. → Set the output setting to SVGA (VPL-ES3) or XGA (VPL-EX3) (see page 14).
The picture flickers.	<p>“Dot Phase” on the INPUT SETTING menu has not been adjusted properly. → Adjust “Dot Phase” on the INPUT SETTING menu properly (see page 26).</p>

Sound

Symptom	Cause and Remedy
No sound.	<ul style="list-style-type: none"> • A cable is disconnected or the connections are wrong. → Check that the proper connections have been made (see page 14). • The audio connecting cable used is incorrect. → Use a no-resistance stereo audio cable (see page 14). • The sound is not adjusted properly. → Adjust the sound with the VOLUME +/- key on the Remote Commander or adjust “Volume” on the PICTURE SETTING menu (see page 25).

Remote Commander

Symptom	Cause and Remedy
The Remote Commander does not work.	<p>The Remote Commander battery are dead. → Replace them with new battery (see page 12).</p>

Others

Symptom	Cause and Remedy
The control panel keys do not function.	The control panel keys are locked. → Unlock the control panel keys (see page 29).

Indicators

Symptom	Cause and Remedy
The LAMP/COVER indicator flashes.	<ul style="list-style-type: none"> The lamp cover or the air filter cover is detached. → Attach the cover securely (see pages 35 and 36). The electrical system may have broken down. → Consult with qualified Sony personnel.
The LAMP/COVER indicator lights up.	<ul style="list-style-type: none"> The lamp has reached the end of its life. → Replace the lamp (see page 34). The lamp has reached a high temperature. → Wait for 45 seconds to cool the lamp and then turn on the power again. If the LAMP/COVER indicator still lights even after you have replaced the lamp, the electrical system may break down. → Consult with qualified Sony personnel.
The TEMP/FAN indicator flashes.	The fan is broken. → Consult with qualified Sony personnel.
The TEMP/FAN indicator lights up.	<ul style="list-style-type: none"> The internal temperature is unusually high. → Check to see that nothing is blocking the ventilation holes. The projector is being used at a high altitude. → Ensure that “High Altitude Mode” on the INSTALL SETTING menu is set to “On.”
Both the LAMP/COVER and TEMP/FAN indicators light up.	The electrical system has broken down. → Consult with qualified Sony personnel.

Messages List

Warning Messages

Use the list below to check the meaning of the messages displayed on the screen.

Message	Meaning and Remedy
Please replace the Lamp.	<ul style="list-style-type: none"> It is time to replace the lamp. → Replace the lamp. When this message appears even after replacing the lamp, the task has not been completed. → Perform the operation of steps 8 and 9 on page 35. → To erase a message, press any key on the control panel of the projector or on the remote commander.
Please clean the filter.	<p>It is time to clean the filter.</p> <p>→ Clean the filter (see page 36).</p> <p>→ To erase a message, press any key on the control panel of the projector or on the remote commander.</p>

Caution Messages

Use the list below to check the meaning of the messages displayed on the screen.

Message	Meaning and Remedy
Not applicable!	You have pressed the wrong key. → Press the appropriate key.
The panel keys are locked!	“Panel Key Lock” on the SET SETTING menu is set to “On.” → All the keys on the control panel of the projector are locked. Operate the projector with the keys on the Remote Commander (see page 29).

Specifications

Optical characteristics

Projection system	3 LCD panels, 1 lens, projection system
LCD panel	VPL-ES3: 0.63-inch SVGA panel, about 1,440,000 pixels (480,000 pixels × 3) VPL-EX3: 0.63-inch XGA panel, about 2,360,000 pixels (786,432 pixels × 3)
Lens	1.2 times zoom lens f 18.8 to 22.6 mm/F1.6 to 1.94
Lamp	165 W Ultra high pressure lamp
Projected picture size	40 to 300 inches (measured diagonally)
Light output	ANSI lumen ¹⁾ 2000 lm (When the Lamp Mode is set to "High.")
Throwing distance (When placed on the floor.)	40-inch: 1.2 to 1.4 m (3.9 to 4.6 feet) 80-inch: 2.3 to 2.8 m (7.5 to 9.2 feet) 100-inch: 2.9 to 3.6 m (9.5 to 11.8 feet) 150-inch: 4.4 to 5.4 m (14.4 to 17.7 feet) 200-inch: 5.9 to 7.2 m (19.4 to 23.6 feet) 250-inch: 7.3 to 9.0 m (24 to 29.5 feet) 300-inch: 8.8 to 10.7 m (28.9 to 35.1 feet)

There may be a slight difference between the actual value and the design value shown above.

¹⁾ ANSI lumen is a measuring method of American National Standard IT 7.228.

Electrical characteristics

Color system	NTSC ^{3.58} /PAL/SECAM/ NTSC ^{4.43} /PAL-M/PAL-N/ PAL60 system, switched automatically/manually (NTSC ^{4.43} is the color system used when playing back a video recorded in NTSC on a NTSC ^{4.43} system VCR.)
Resolution	VPL-ES3: 500 horizontal TV lines (Video input) 800 × 600 dots (RGB input) VPL-EX3: 750 horizontal TV lines (Video input)

1024 × 768 dots (RGB input)
Acceptable computer signals¹⁾
fH: 19 to 92 kHz
fV: 48 to 92 Hz
(Maximum input signal resolution:
SXGA+ 1400 × 1050
fV: 60 Hz)

¹⁾ Set the resolution and the frequency of the signal of the connected computer within the range of acceptable preset signals of the projector.

Applicable video signals

15 k RGB 50/60 Hz, Progressive component 50/60 Hz, DTV (480/60i, 575/50i, 480/60p, 575/50p, 720/60p, 720/50p, 1080/60i, 1080/50i), Composite video, Y/C video

Speaker Monaural speaker system, 40 × 20 mm (1⁵/₈ × 1³/₁₆ inches)

Speaker output 1 W (max.)

Input/Output

Video input VIDEO: phono type
Composite video: 1 Vp-p ±2 dB sync negative (75 ohms terminated)
S VIDEO: Y/C mini DIN 4-pin type
Y (luminance): 1 Vp-p ±2 dB sync negative (75 ohms terminated)
C (chrominance): burst 0.286 Vp-p ±2 dB (NTSC) (75 ohms terminated), burst 0.3 Vp-p ±2 dB (PAL) (75 ohms terminated)

INPUT A HD D-sub15-pin (female)
Analog RGB/component:
R/R-Y: 0.7 Vp-p ±2 dB (75 ohms terminated)
G: 0.7 Vp-p ±2 dB (75 ohms terminated)
G with sync/Y: 1 Vp-p ±2 dB sync negative (75 ohms terminated)
B/B-Y: 0.7 Vp-p ±2 dB (75 ohms terminated)
SYNC/HD: Composite sync input: TTL level, positive/negative
Horizontal sync input: TTL level
Positive/negative VD:
Vertical sync input: TTL level, positive/negative

INPUT B (VPL-EX3 only)

HD D-sub 15-pin (female)
 Analog RGB:
 R: 0.7 Vp-p ± 2 dB
 (75 ohms terminated)
 G: 0.7 Vp-p ± 2 dB
 (75 ohms terminated)
 G with sync/Y: 1 Vp-p ± 2 dB
 sync negative
 (75 ohms terminated)
 B: 0.7 Vp-p ± 2 dB
 (75 ohms terminated)
 SYNC/HD: Composite sync
 input: TTL level, positive/
 negative
 Horizontal sync input: TTL
 level
 Positive/negative VD:
 Vertical sync input: TTL
 level, positive/negative

AUDIO INPUT A/B (VPL-EX3 only)

Stereo minijack,
 500 mVrms, input impedance 47
 kilohms
 AUDIO Stereo minijack,
 500 mVrms, input impedance 47
 kilohms

OUTPUT MONITOR OUT: HD D-sub 15-pin (female)

R, G, B: Gain Unity: 75 ohms
 SYNC/HD, VD: 4 Vp-p (open),
 1 Vp-p (75 ohms)
 AUDIO OUT (variable out):
 Stereo minijack
 1 Vrms (When the volume is
 maximum and an input signal is
 500 mVrms), output impedance
 5 kilohms
 REMOTE RS-232C: D-sub 9 pin

General

Dimensions 308 \times 98 \times 252 mm (12 $\frac{1}{4}$ \times
 3 $\frac{7}{8}$ \times 10 inches) (w/h/d)
 (without projecting parts)
 Mass Approx. 2.9 kg (6 lb 8 oz)
 Power requirements
 AC 100 to 240 V, 2.2 to 1.0 A, 50/
 60 Hz
 Power consumption
 Max. 220 W
 in standby: 10 W
 Heat dissipation
 750.7 BTU
 Operating temperature
 0°C to 35°C (32°F to 95°F)
 Operating humidity
 35% to 85% (no condensation)
 Storage temperature
 -20°C to +60°C (-4°F to +140°F)
 Storage humidity
 10% to 90%

Supplied accessories

Remote Commander (1)
 Lithium battery CR2025 (1)
 HD D-sub 15 pin cable (1.8 m) (1)
 (1-832-428-11, SONY)
 Carrying case (1)
 AC power cord (1)
 Operating Instructions (CD-ROM)
 (1)
 Quick Reference Manual (1)
 Safety Regulations (1)
 Security Label (1)

Design and specifications are subject to change
 without notice.

Optional accessories

Projector Lamp
 LMP-C162(for replacement)

*Some of the items may not be available in
 some areas. For details, please consult your
 nearest Sony dealer.*

Pin assignment

INPUT A connector (HD D-sub 15-pin, female)

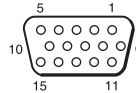

1	R/R-Y	9	N.C.
2	G/Y	10	GND
3	B/B-Y	11	GND
4	GND	12	DDC/SDA
5	GND	13	HD/C.Sync
6	GND (R)	14	VD
7	GND (G)	15	DDC/SCL
8	GND (B)		

INPUT B connector (HD D-sub 15-pin, female) (VPL-EX3 only)

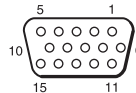

1	R	9	N.C.
2	G	10	GND
3	B	11	GND
4	GND	12	DDC/SDA

5	GND	13	HD/C.Sync
6	GND (R)	14	VD
7	GND (G)	15	DDC/SCL
8	GND (B)		

RS-232C connector (D-sub 9 pin, female)

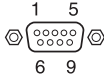

1	DCD	6	DSR
2	RXDA	7	RTS
3	TXDA	8	CTS
4	DTR	9	RI
5	GND		

Preset signals

Memory No.	Preset signal		fH (kHz)	fV (Hz)	Sync
1	Video 60 Hz	60 Hz	15.734	59.940	–
2	Video 50 Hz	50 Hz	15.625	50.000	–
3	480/60i	480/60i	15.734	59.940	S on G/Y
4	575/50i	575/50i	15.625	50.000	S on G/Y
5	480/60p	480/60p (Progressive component)	31.470	60.000	S on G/Y
6	575/50p	575/50p (Progressive component)	31.250	50.000	S on G/Y
7	1080/60i	1035/60i, 1080/60i	33.750	60.000	S on G/Y
8	1080/50i	1080/50i	28.130	50.000	S on G/Y
10	720/60p	720/60p	45.000	60.000	S on G/Y
11	720/50p	720/50p	37.500	50.000	S on G/Y
21	640 × 350	VGA mode 1	31.469	70.086	H-pos, V-neg
22		VGA VESA 85 Hz	37.861	85.080	H-pos, V-neg
23	640 × 400	PC-9801 Normal	24.823	56.416	H-neg, V-neg
24		VGA mode 2	31.469	70.086	H-neg, V-pos
25		VGA VESA 85 Hz	37.861	85.080	H-neg, V-pos
26	640 × 480	VGA mode 3	31.469	59.940	H-neg, V-neg
27		Macintosh 13"	35.000	66.667	H-neg, V-neg
28		VGA VESA 72 Hz	37.861	72.809	H-neg, V-neg
29		VGA VESA 75 Hz	37.500	75.000	H-neg V-neg
30		VGA VESA 85 Hz	43.269	85.008	H-neg V-neg
31	800 × 600	SVGA VESA 56 Hz	35.156	56.250	H-pos, V-pos
32		SVGA VESA 60 Hz	37.879	60.317	H-pos, V-pos
33		SVGA VESA 72 Hz	48.077	72.188	H-pos, V-pos
34		SVGA VESA 75 Hz	46.875	75.000	H-pos, V-pos
35		SVGA VESA 85 Hz	53.674	85.061	H-pos, V-pos
36	832 × 624	Macintosh 16"	49.724	74.550	H-neg, V-neg
37	1024 × 768	XGA VESA 60 Hz	48.363	60.004	H-neg, V-neg
38		XGA VESA 70 Hz	56.476	69.955	H-neg, V-neg
39		XGA VESA 75 Hz	60.023	75.029	H-pos, V-pos
40		XGA VESA 85 Hz	68.677	84.997	H-pos, V-pos
41	1152 × 864	SXGA VESA 70 Hz	63.995	70.019	H-pos, V-pos
42		SXGA VESA 75 Hz	67.500	75.000	H-pos, V-pos
43		SXGA VESA 85 Hz	77.487	85.057	H-pos, V-pos
44	1152 × 900	Sunmicro LO	61.795	65.960	H-neg, V-neg

Memory No.	Preset signal		fH (kHz)	fV (Hz)	Sync
45	1280 × 960	SXGA VESA 60 Hz	60.000	60.000	H-pos, V-pos
46		SXGA VESA 75 Hz	75.000	75.000	H-pos, V-pos
47	1280 × 1024	SXGA VESA 60 Hz	63.974	60.013	H-pos, V-pos
48		SXGA VESA 75 Hz	79.976	75.025	H-pos, V-pos
49*		SXGA VESA 85 Hz	91.146	85.024	H-pos, V-pos
50	1400 × 1050	SXGA+ 60 Hz	63.981	60.020	H-neg, V-neg

Notes

- When a signal other than the preset signals shown above is input, the picture may not be displayed properly.
- For the Memory No.49*, the smart APA function and the APA key of the remote commander do not active. Make adjustments for the input signal using the Adjust Signal... on the INPUT SETTING menu.
- When an SXGA+ signal is input, the image may extend beyond the edges of the screen. In this case, input a signal with no black edges around the image, and disconnect and reconnect the cable or select the input signal by pressing the INPUT key.

Installation Diagram

Floor Installation (Front Projection)

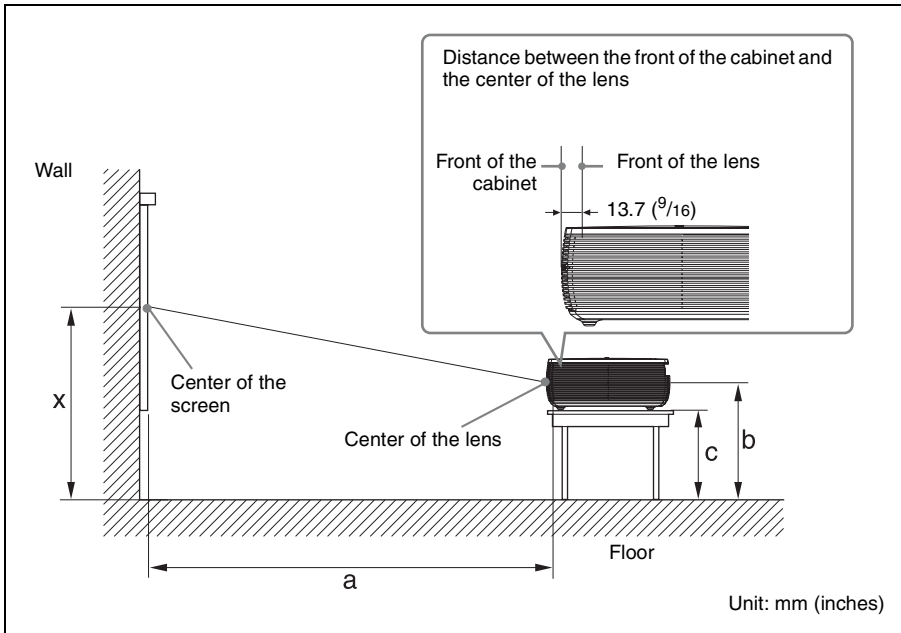

This section describes the examples of installing the projector on a desk, etc.

See the chart on page 47 concerning the installation measurements.

The alphabetical letters in the illustration indicate the distances below.

- a:** distance between the screen and the center of the lens
- b:** distance between the floor and the center of the lens
- c:** distance between the floor and the bottom of the adjusters of the projector
- x:** distance between the floor and the center of the screen (free)

SS		40	60	80	100	120	150	180	200	250	300
a	N	1190 (46 ⁷ / ₈)	1800 (70 ⁷ / ₈)	2400 (94 ¹ / ₂)	3010 (118 ¹⁷ / ₃₂)	3620 (142 ⁵ / ₈)	4530 (178 ³ / ₈)	5440 (214 ¹ / ₄)	6040 (237 ⁷ / ₈)	7560 (297 ³ / ₄)	9080 (357 ⁵ / ₈)
	M	1370 (54)	2070 (81 ³ / ₈)	2760 (108 ³ / ₄)	3460 (136 ¹ / ₄)	4160 (163 ⁷ / ₈)	5200 (204 ³ / ₄)	6240 (245 ³ / ₄)	6940 (273 ³ / ₈)	8680 (341 ⁷ / ₈)	10420 (410 ³ / ₈)
b		x-203 (x-8)	x-305 (x-12 ¹ / ₈)	x-406 (x-16)	x-508 (x-20)	x-610 (x-24 ¹ / ₈)	x-762 (x-30)	x-914 (x-36)	x-1016 (x-40)	x-1270 (x-50)	x-1524 (x-60)
c		x-271 (x-10 ³ / ₄)	x-372 (x-14 ³ / ₄)	x-474 (x-18 ³ / ₄)	x-576 (x-22 ³ / ₄)	x-677 (x-26 ³ / ₄)	x-830 (x-32 ³ / ₄)	x-982 (x-38 ³ / ₄)	x-1084 (x-42 ³ / ₄)	x-1338 (x-52 ³ / ₄)	x-1592 (x-62 ³ / ₄)

(The above-mentioned numerical values differ from the design values because the values in the table include a tolerance.)

$$a (N) = \{(SS \times 18.56/0.6299) - 24.0\} \times 1.03$$

$$a (M) = \{(SS \times 22.61/0.6299) - 24.0\} \times 0.97$$

$$b = x - (SS/0.6299 \times 3.2)$$

$$c = x - (SS/0.6299 \times 3.2 + 67.6)$$

The installation measurements and their calculation method for each lens are shown above.

The alphabetical letters in the charts and calculation methods indicate the following.

SS: screen size measured diagonally (inches)

a: distance between the screen and the center of the lens

b: distance between the floor and the center of the lens

c: distance between the floor and the adjusters of the projector

x: free

N: minimum

M: maximum

Ceiling Installation (Front Projection)

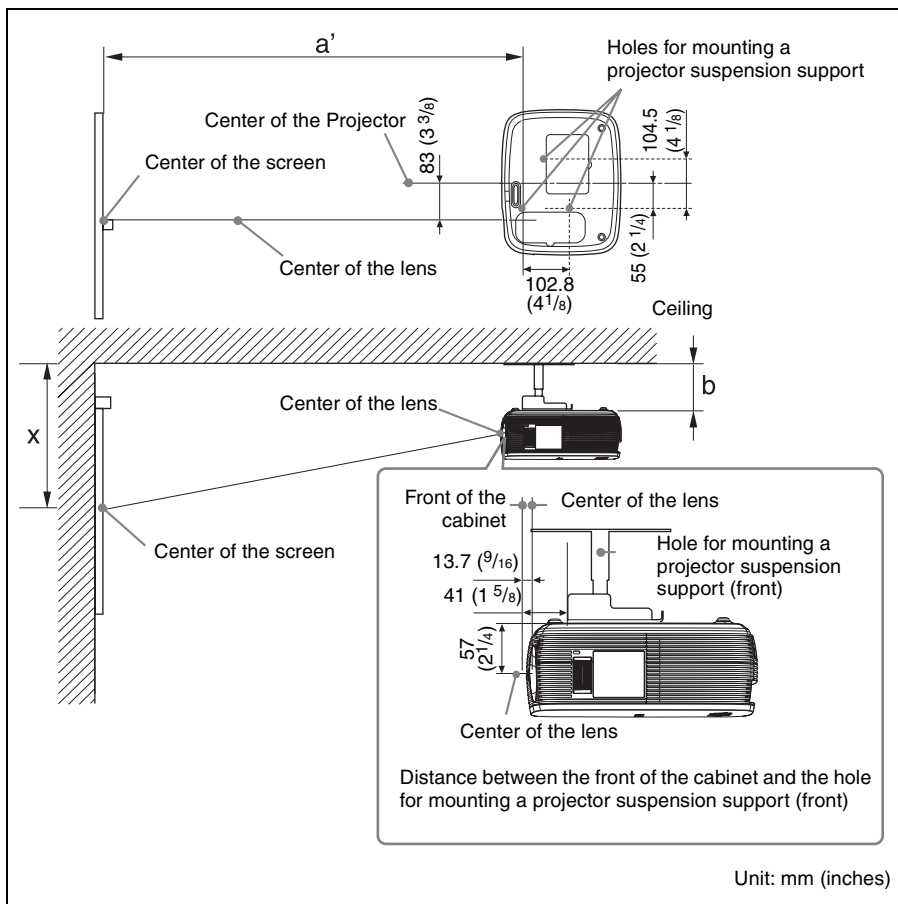

This section describes the examples for installing the projector on the ceiling.

When installing the projector on the ceiling, use a Projector Suspension Support recommended by Sony.

For ceiling installation, ask for qualified Sony personnel.

See the chart on page 49 concerning the installation measurements.

The alphabetical letters in the illustrations indicate the distances below.

a': distance between the hole (front) for mounting a projector suspension support on bottom surface of this projector and the center of the screen

b: distance between the hole (front) for mounting a projector suspension support on bottom surface of this projector and the ceiling

x: distance between the ceiling and the center of the screen

SS		40	60	80	100	120	150	180	200	250	300
a'	N	1220 (48 1/8)	1820 (71 3/4)	2430 (95 3/4)	3040 (119 3/4)	3640 (143 3/8)	4550 (179 1/4)	5470 (215 1/2)	6070 (239 1/8)	7590 (298 7/8)	9110 (358 3/4)
	M	1440 (55 1/8)	2090 (82 3/8)	2790 (109 7/8)	3490 (137 1/2)	4180 (164 3/8)	5230 (206)	6270 (247)	6970 (274 1/2)	8710 (343)	10450 (411 1/2)
x		b+260 (b+10 1/4)	b+362 (b+14 3/8)	b+463 (b+18 1/4)	b+565 (b+22 1/4)	b+667 (b+26 3/8)	b+819 (b+32 1/4)	b+971 (b+38 1/4)	b+1073 (b+42 1/4)	b+1327 (b+52 1/4)	b+1581 (b+62 1/4)
b	Free										

(The above-mentioned numerical values differ from the design values because the values in the table include a tolerance.)

$$a'(N) = \{(SS \times 18.56/0.6299) + 3.3\} \times 1.03$$

$$a'(M) = \{(SS \times 22.61/0.6299) + 3.3\} \times 0.97$$

$$x = b + (SS/0.6299 \times 3.2 + 57.0)$$

The installation measurements and their calculation method for each lens are shown above.

The alphabetical letters in the charts and calculation methods indicate the following.

SS: screen size measured diagonally (inches)

a': distance between the hole (front) for mounting a projector suspension support on bottom surface of this projector and the center of the screen

b: distance between the hole (front) for mounting a projector suspension support on bottom surface of this projector and the ceiling

x: distance between the center of the screen and the ceiling

N: minimum

M: maximum

Dimensions

Front

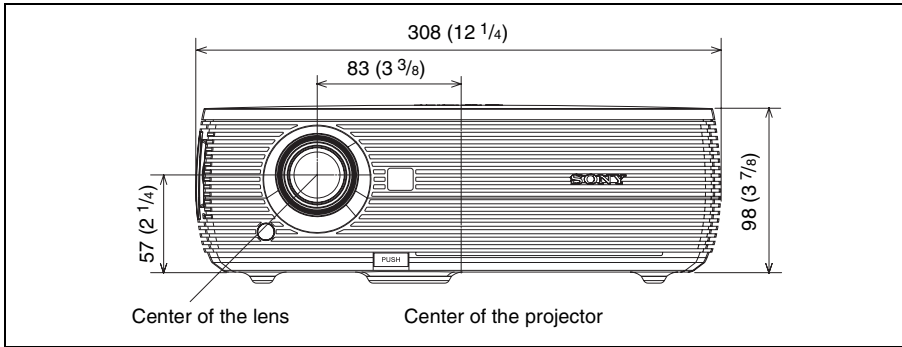

Side

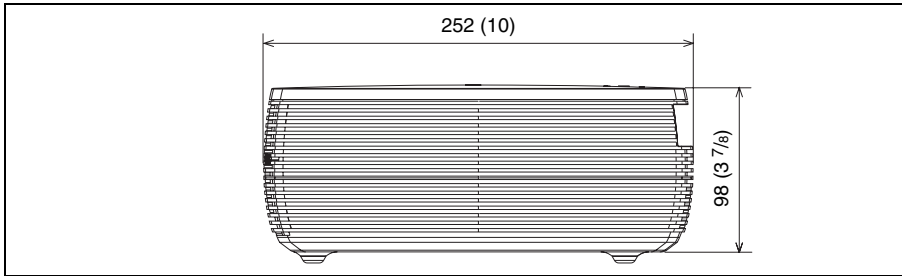

Top

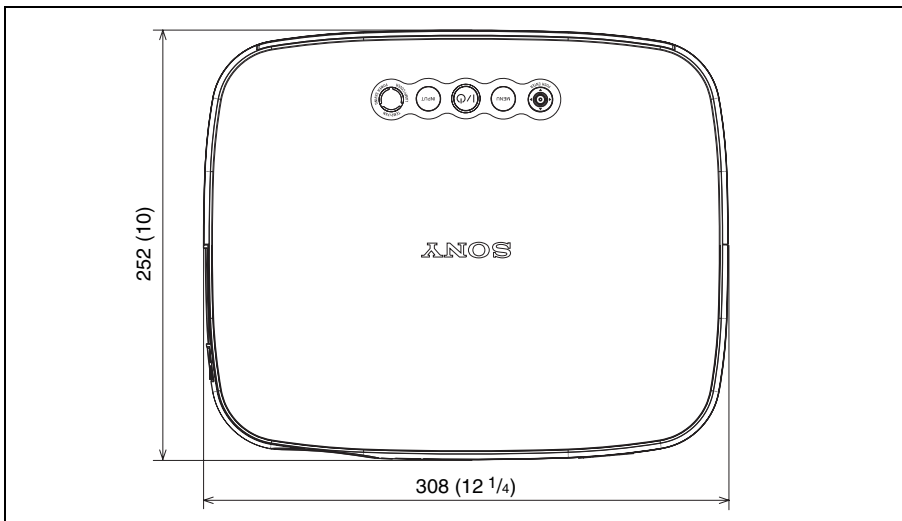

Unit: mm (inches)

Index

A

- Adjusting
 - memory of the settings 24
 - the picture 25
 - the picture size/shift 26, 27
- Air filter 36
- Auto Input Search 28

B

- Background 31
- Batteries 12
- Brightness 25

C

- Color 25
- Color System 28
- Color Temp. 25
- Connecting a computer 14
- Connecting a VCR 15
- Contrast 25

D

- Digital Zoom function 21
- Dot Phase 26

F

- fH (Horizontal Frequency) 32
- fV (Vertical Frequency) 32

G

- Gamma Mode 25

H

- H Size 26
- High Altitude Mode 31
- Hue 25

I

- Image Flip 31
- Input-A Signal Sel. 28
- Installation 13
 - notes 6
 - unsuitable conditions 7
 - unsuitable installation 6
- IR Receiver 29

L

- Lamp Mode 31
- Lamp replacement 34
- Lamp Timer 32
- Language 30
 - selecting the menu language 19
- Lens 9
- Location and function of controls
 - connector panel 11
 - control panel 10
 - rear/bottom 9
 - Remote Commander 11
 - top/right side/front 9

M

- Menu
 - clearing the menu display 24
 - INFORMATION Menu 32
 - INPUT SETTING menu 26
 - INSTALL SETTING menu 31
 - MENU SETTING menu 30
 - PICTURE SETTING menu 25
 - SET SETTING menu 28
 - using a menu 23
- Menu Position 30
- Message List
 - caution 40
 - warning 39

O

- Optional accessories 42

P

- Panel Key Lock 29
- Picture Mode 25
- Pin assignment 42
- Power
 - turn on 16
- Power Saving 28
- Projecting 16

R

- Remote Commander 11
 - front remote control detector 9, 29
 - location and function of controls 11
 - rear remote control detector 9, 29
- Reset
 - resetting an item 24
- RS-232C connector 43

S

Scan Converter	27
Screen size	13, 41
Security Lock	20, 31
Sharpness	25
Shift	27
Smart APA	28
Specifications	41
Status	30
Supplied accessories	42

T

Troubleshooting	37
-----------------------	----

V

V Keystone	31
Volume	25

W

Wide Mode	26
-----------------	----

